

SERVED BY
BREW|LOCK

DAVIDXL
GREEN

Brewlock User Manual



Content

1. Safety instructions and warnings	3
1.1 General	3
1.2 Fridge areas	3
1.3 Customer contact	3
2. Introduction	4
3. Disposal notes	4
4. Range of appliance use	4
5. Climate rating	4
6. Preparation	4
6.1 Setting up	4
6.2 Connecting to the mains	4
6.3 Switching appliance on and off	5
6.4 Air ventilation	5
6.5 Compressor	5
7. Description of appliance and equipment	6
7.1 Built in version	6
7.2 Mobile version	6
8. Use of appliance	7
8.1 Pouring beer	7
8.2 Removing the keg	7
8.3 Installing the keg	7
8.4 Precooling the keg	7
8.5 Cleaning	8
8.6 Alarm messages	8
9. Shutting your appliance down	8
10. Technical Specifications	8
11. Troubleshooting	9
11.1 Troubleshooting fridge	9
11.2 Troubleshooting compressor	9

1. Safety instruction and warnings

1.1 General

- To prevent injury or damage to the unit, the appliance should be unpacked and set up by two people.
- In the event that the appliance is damaged on delivery, contact the supplier immediately before connecting to the mains.
- To guarantee safe operation, ensure that the appliance is set up and connected as described in this installation manual.
Disconnect the appliance from the mains if any fault occurs. Pull out the plug, switch off or remove the fuse.
- When disconnecting the appliance, pull on the plug, not on the cable.
- Any repairs and work on the appliance should only be carried out by the customer service department, as unauthorised work could prove highly dangerous for the user. The same applies to changing the mains power cable.
- Never use this appliance with a damaged power cord. A power cord which is damaged should be replaced immediately.
- Do not allow naked flames or ignition sources to enter the appliance. When transporting and cleaning the appliance ensure that the refrigerant circuit is not damaged. In the event of damage, make sure that there are no ignition sources nearby and keep the room well ventilated.
- The appliance is unsuited for use in areas exposed to an explosion hazard.
- Do not stand on the plinth, drawers or doors or use them to support anything else.
- This appliance is not intended for use by persons (including children) with reduced physical, sensory or mental capabilities or lack of experience and knowledge unless they have been given initial supervision or instruction concerning use of the appliance by a person responsible for their safety. Children should be supervised to ensure that they do not play with the appliance.
- If you have lockable appliance, do not keep the key near the appliance or within reach of children.
- Access to the service area is restricted to persons having knowledge and practical experience of the appliance.
- The appliance is only to be installed in locations where its use and maintenance is restricted to trained personnel.
- Avoid prolonged skin contact with cold surfaces or chilled/frozen food. This could cause pain, numbness and frostbite. In case of prolonged skin contact, protective measures should be taken, e.g. gloves should be worn.
- Do not use electrical appliances inside the appliance.

- Do not consume food which has been stored for too long, as it could cause food poisoning.
- Do not store explosives or sprays using combustible propellants such as butane, propane, pentane etc. in the appliance. Electrical components might cause leaking gas to ignite. You may identify such sprays by the printed contents or a flame symbol.
- The appliance is designed for use in enclosed areas. Do not operate the appliance outdoors or in areas where it is exposed to splash water or damp conditions.
- The Appliance is not suitable for installation in an area where a water jet could be used.
- Special-purpose lamps (incandescent lamps, LEDs, fluorescent tubes) in the appliance serve to illuminate the appliance interior and are not suited for room illumination.
- Maximal installation height to use the David system: 2 km above sea level.
- Handle the David draught beer installation with care.
- Illuminated column (LED lights) may only be used with the internal adaptor for illumination of the appliance.

1.2 Fridge areas

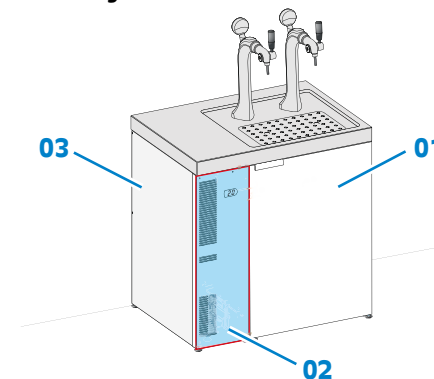

Legenda

- 01 User area / Cabinet
- 02 Service area behind front cover (Sheet metal)
- 03 Cooling cassette

1.3 Customer contact

When contacting your supplier or the Service Department, please quote the model and serial number of your appliance. Both of which are shown on the type label visible inside the cooling cabinet.

You can download the user manual for your appliance from the Heineken website (www.draughtsystems.heineken.com).

2. Introduction

The David XL Green draught beer installation has been designed specifically to simply use four kegs in a well-cooled and hygienic way.

The newly designed refrigeration system provides rapid cooling of newly placed (warm) kegs as well as a cooled counter mount and beer tube even at high ambient temperatures.

The refrigerator system is using Hydro Carbon refrigerant and high efficient components, to reduce the energy consumption and environmental impact.

This user manual provides instructions for the use of the draught beer installation. In this manual you will also find the safety regulations you must observe while using the machine. Always keep this manual with the draught beer installation, so you can consult it when necessary.

Read the operating instructions before switching on for the first time.

3. Disposal notes

Keep packaging materials away from children
- polythene sheets and bags can cause suffocation!



- Please return the packaging to an official collection point.

Your old appliance: This contains some reusable materials and should be disposed of properly - not simply with unsorted household refuse.

- Discarded appliances should be disabled: Remove the plug, cut through the connection cable and render the catch unusable so that children cannot become trapped inside.
- Ensure that the refrigerant circuit is not damaged when the appliance that is no longer needed is taken away for disposal.
- Details of the refrigerant can be found on the type plate.
- Appliances which are no longer needed must be disposed of in a professional and appropriate way, in accordance with the current local regulations and laws.

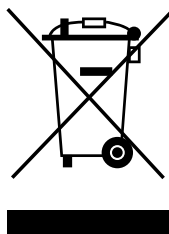

4. Range of appliance use

- The appliance is suited only for cooling beer kegs and non alcohol or low alcohol beverage kegs.
- In the case of commercial food cooling, the pertinent statutory regulations have to be observed.
- The appliance is not suited for storing and cooling pharmaceuticals, blood plasma, laboratory preparations or similar substances and products subject to the Medical Devices Directive 2007/47/EC.
- Any misuse of the appliance may result in damage to or spoilage of the stored goods.
- Furthermore, the appliance is unsuited for use in areas exposed to an explosion hazard.

5. Climate rating

The appliance is set to operate within specific ambient temperature limits according to its climate rating. These temperature limits should not be exceeded.

	Ambient temperatures	Relative Humidity
Single / Twin tap	+10 °C to +38°C	75% RH

6. Preparation

6.1 Setting up

- Avoid positioning the appliance in direct sunlight or near cookers, radiators and similar sources of heat.
- The floor on which the appliance stands should be horizontal and level. Compensate for uneven floors with the adjustable feet.
- Always ensure that there is good ventilation and that the outward flowing air is able to escape.
- Standard EN 378 specifies that the room in which you install your appliance must have a volume of 1 m³ per 8 g of R 290 refrigerant used in the appliance, so as to avoid the formation of inflammable gas/air mixtures in the room where the appliance is located in the event of a leak in the refrigerant circuit. The quantity of refrigerant used in your appliance is indicated on the type plate on the inside of the appliance.
- Do not connect the appliance to the supply with other equipment using an extension cable - risk of overheating.
- Before moving the appliance to another position, make sure that the plug is removed from the electricity supply.

6.2 Connecting to the mains

Connect the appliance with a properly earthed fused plug and socket only.



Power supply (a.c.) and voltage at the operating point must comply with the details on the type plate. The socket must be fused with a 10 A fuse or higher (Max 16 A), it must be away from the rear of the appliance and must be easily accessible.

The power plug must be accessible after the appliance has been built in.

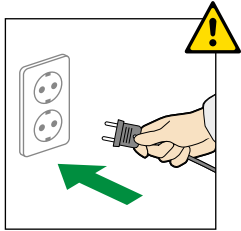
6.3 Switching appliance on and off

To switch the appliance on: Connect the appliance to the mains - the appliance is switched on.

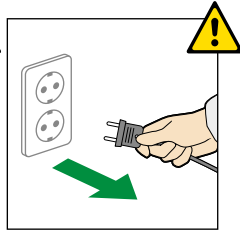

To switch the appliance off: Pull out the mains plug.

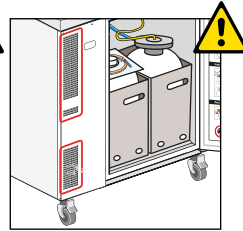
6.4 Air ventilation

Always keep the air ventilation grill open!
Do not block the airflow.

6.5 Compressor

Specific instructions see:

1. for installations as showed in 7.1:
 - Work instruction 079XE-001-OA
 - Installation and user manual DSCU
2. for installations as showed in 7.2
 - Installation and user manual DSMC-upgrade

7. Description of appliance and equipment

7.1 Built in version

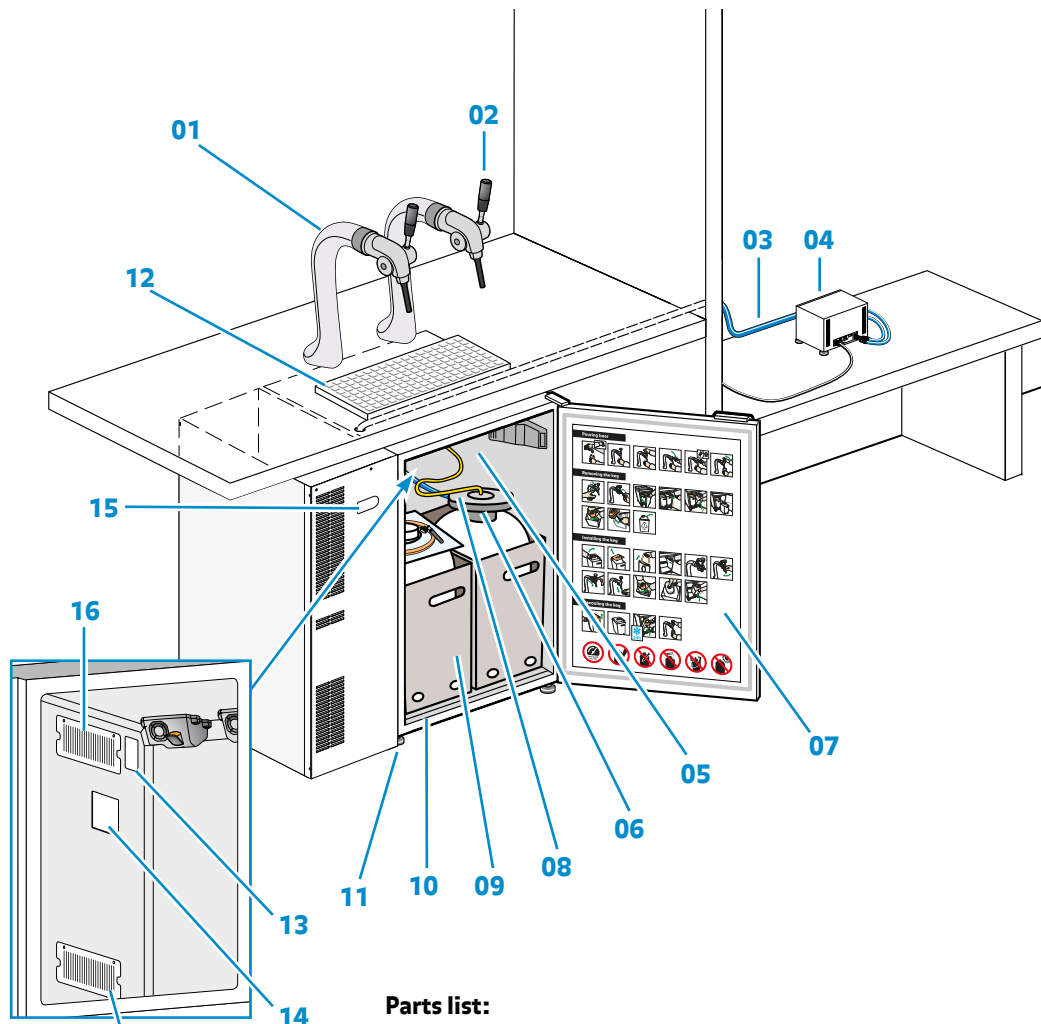

Parts list:

- | | |
|----------------------------|---|
| 01 Counter mount | 10 Keg support frame |
| 02 Dispense tap | 11 Adjustable feet |
| 03 Air hose | 12 Drip tray |
| 04 Compressor | 13 Type plate |
| 05 Beer tube inlet | 14 Fridge light |
| 06 Air coupler | 15 Controller display |
| 07 Quick reference sticker | 16 Air ventilation grill |
| 08 Beer tube | 17 Air ventilation grill
(Removable) |
| 09 Beer keg | |

7.2 Mobile version

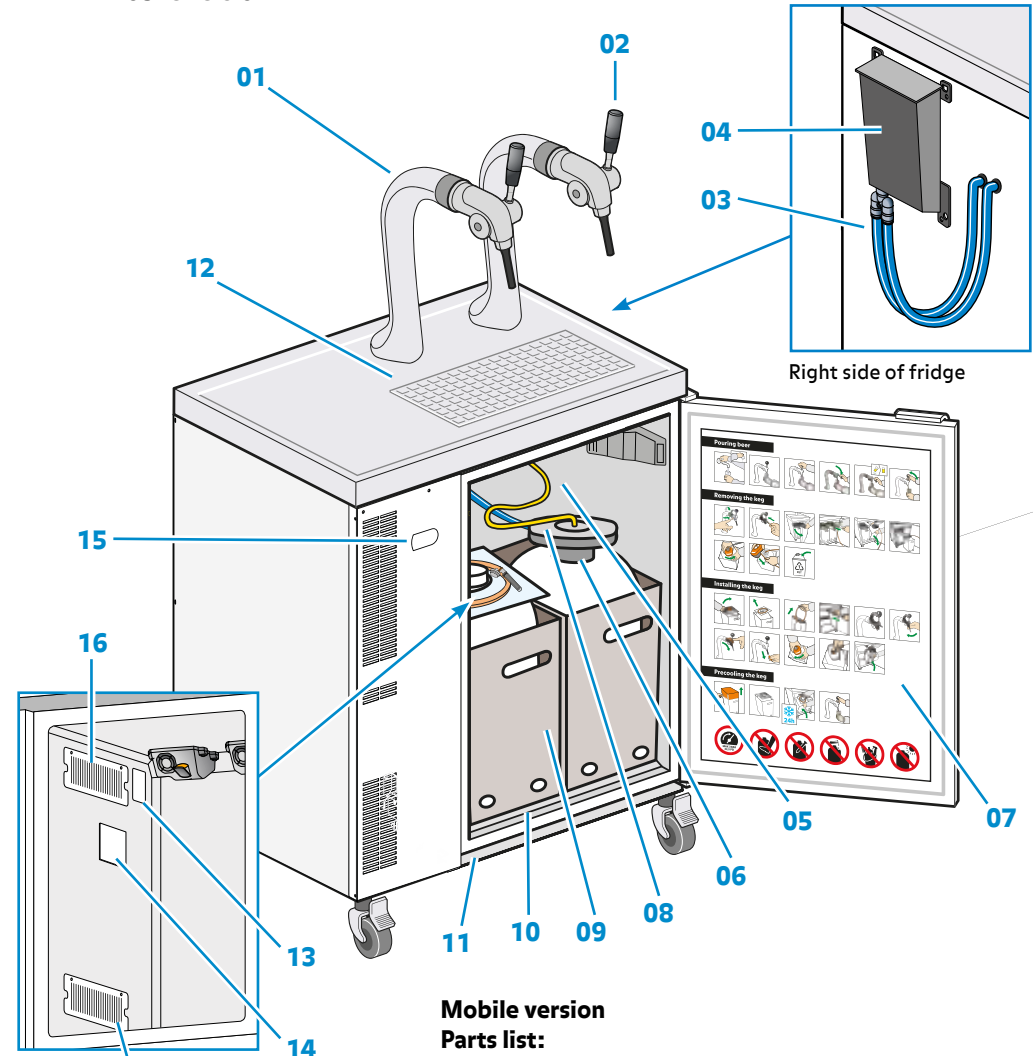

**Mobile version
Parts list:**

- | | |
|----------------------------|---|
| 01 Counter mount | 10 Keg support frame |
| 02 Dispense tap | 11 Wheel cart |
| 03 Air hose | 12 Drip tray |
| 04 Compressor | 13 Type plate |
| 05 Beer tube inlet | 14 Fridge light |
| 06 Air coupler | 15 Controller display |
| 07 Quick reference sticker | 16 Air ventilation grill |
| 08 Beer tube | 17 Air ventilation grill
(Removable) |
| 09 Beer keg | |

8. Use of appliance

8.1 Pouring beer

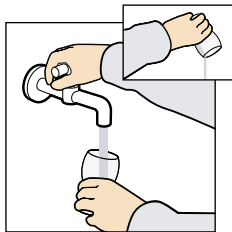

1. Always use glasses rinsed with water

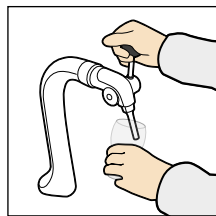

2. Hold glass in a tilted position

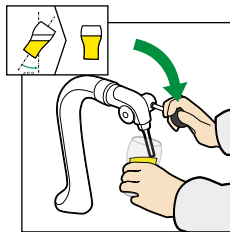

3. Open tap
4. Dispense beer

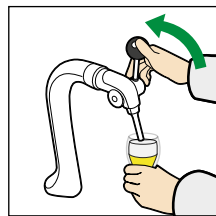

5. Close tap when glass is full. Cheers!

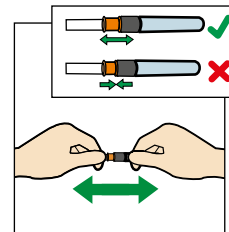

6. Check beer spout

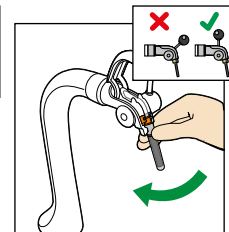

6. Insert beer spout in dispense tap

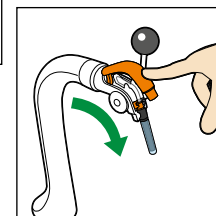

7. Close dispense tap

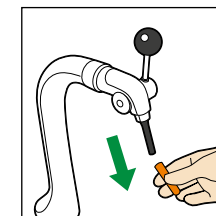

8. Remove hygienic cap

8.2 Removing the keg

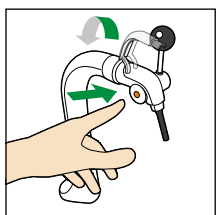

1. Push knob to open dispense tap

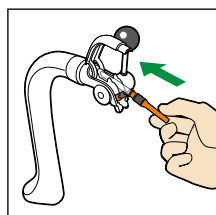

2. Disconnect beer spout

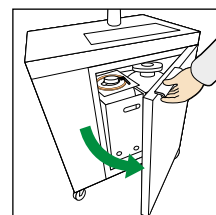

3. Open fridge

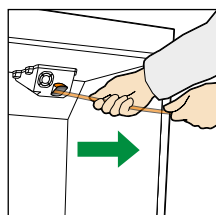

4. Remove beer line

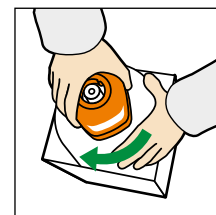

9. Place dispense tool

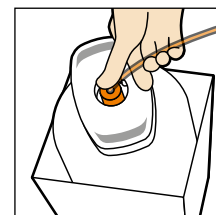

10. Place beerline in airkeg

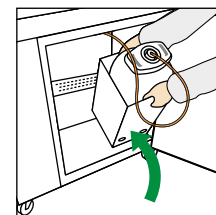

11. Place Airkeg in fridge

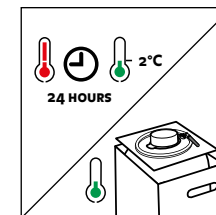

12. Use precooled keg or wait for 24 hours before pouring

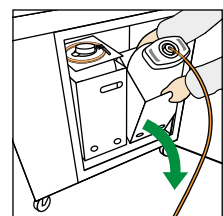

5. Remove keg

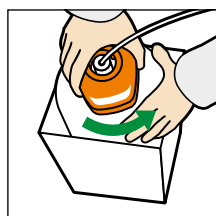

6. Disconnect dispense tool

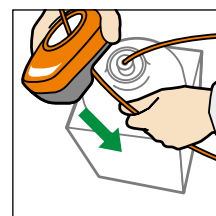

7. Remove beer line from Airkeg



8. Recycle the Airkeg

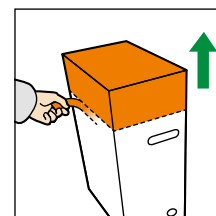

1. Remove the top of the packaging

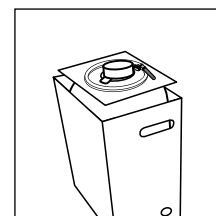

2. Place the Airkeg in the fridge

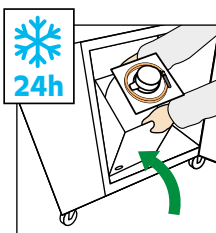

3. Close fridge door

8.3 Installing the keg

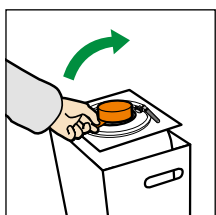

1. Remove cap

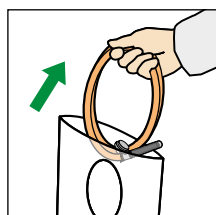

2. Unpack beer line

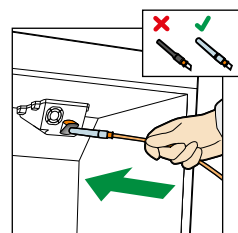

3. Insert beer tube with hygienic cap

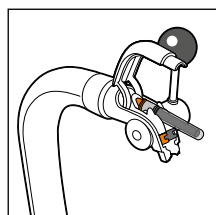

4. Push until it appears at dispense tap



8. USE OF APPLIANCE

8.5 Cleaning

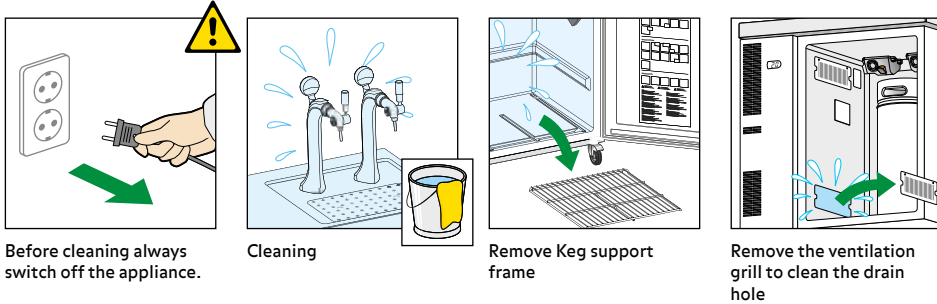

Before cleaning always switch off the appliance.

Cleaning

Remove Keg support frame

Remove the ventilation grille to clean the drain hole

- Do not disassemble the dispense system. Do not open the machine. If you have any problems contact your supplier.
- Before cleaning always switch off the appliance. Pull out the mains plug or remove/unscrew the fuse.
- Do not use steam cleaners because of the risk of injury and damage.



- Clean the inside, equipment parts and outer walls with lukewarm water and a little detergent. Do not use abrasive or acid cleaners or chemical solvents.
- Ensure that no cleaning water penetrates into the electrical components or ventilation grille.
- Clean the drain hole in the refrigerator compartment with a thin object, e.g. cotton swab or the like.
- Do not damage or remove the type plate on the inside of the appliance. It is very important for servicing purposes.
- The appliance must be cleaned 2 times a year
- About 1-2 times a year the condenser grid should be removed from its place in order to undust the condenser pipe-system.
- Cleaning increases the lifetime of the machine and has an influence on the performance and electric consumption. A soft brush or vacuum cleaner may be used for cleaning.

8.6 Alarm message

The appliance contains an alarm that sounds as soon as the door is opened for more than 2 minutes. Close the door to stop the alarm. Make sure both kegs are positioned correctly.

9. Shutting your appliance down

If your appliance is to be shut down for any length of time, switch it off and disconnect the plug or remove the fuse. Clean the appliance and leave the door open in order to prevent unpleasant smells. The appliance complies with the relevant safety regulations and EC directives 2004/108/EC and 2006/95/EC.

10. Technical Specifications

Technical specifications of the David XL beer installation

Dimensions of fridge outside (excluding door handle)	836 x 858 x 597 mm (height x width x depth)
Minimum Built-in dimensions	870 x 875 x 600 mm (height x width x depth)
Mains supply	See type label inside fridge
Electrical connecting rating	See type label inside fridge
Climate class	7
Maximum working conditions	+ 38°C / 75% Relative Humidity
Minimum working conditions	+ 10°C / 75% Relative Humidity
Setpoint range	+ 0°C to +6°C
Default setpoint	+ 2°C (locked setpoint)
Defrosting	The refrigerator compartment defrosts automatically
Keg storage	4 x 20 Liter David beer kegs of specific dimensions
Cooling down time (at 38°C / 75% RH)	For one full beer keg from +38°C to +2°C in maximum 24 hours
Keg interchange	Less than 1 minute
Refrigerant	See type label inside fridge
Energy consumption (at 25°C / 60% RH)	Less then 2,0 kWh/24h (steady state)
Weight of the fridge	54 kg
Noise level	Less then 50dB(A)
Start up delay	3 Minutes
Cabinet illumination	3 Watt LED
Counter mount	One or two Counter mounts with cold air circulation
Dispense tap (DTA)	15 or 90 degrees stroke angle (must be connected with disposable beer tube)
Air coupler	Air supply by compressor to maintain ideal pressure above equilibrium. Safety valve 3,6 bar.
Compressor	Compressor DSMU-upgrade: adjustable 0,75 to 1,5 bar Compressor DSCU: adjustable 0,5 to 3,0 bar
Tenability	30 days after connecting the beer container
I.P. rating	For indoor use only (IPX0)
Alarm message (acoustic)	Alarm will be activated when the door is opened for more than 2 minutes or when the cabinet temperature is too low or too high for more than 3 hours.
Not included	• Beer container • Disposable Beer Tube

11. Troubleshooting

11.1 Troubleshooting fridge

Problem	Possible cause	Solution
There is too much foam	<ul style="list-style-type: none"> • Beer has not rested long enough. • The beer is too warm • The fridge is not plugged in. • The dispense tap has not been opened completely or was opened too slowly. • There is a kink in the beer line. • Compressor setting too high, beerflow too high. 	<ul style="list-style-type: none"> • Allow the keg 6 hours rest • Check the time when the keg was placed in the fridge. Keg must be cooled for at least 24 hours. • Put the plug of the fridge into the socket and wait for 24 hours • Put the handle towards you in one fast movement • Remove kink from beer line • Decrease pressure.
There is too less foam	<ul style="list-style-type: none"> • Compressor setting too low • Air coupler is disconnected from broached keg 	<ul style="list-style-type: none"> • Increase pressure above equilibrium • Never disconnect the air coupler from a broached keg
There is (practically) no beer running from the tap	<ul style="list-style-type: none"> • The keg is not connected correctly. • There is a kink in the beer line or air hose. • The keg is empty. • Compressor switch off. • Air coupler is not activated. 	<ul style="list-style-type: none"> • Check the connection to the keg, make sure the temper evident seal (aluminum seal) is removed from the keg. • Remove kink from the beer line or air hose. • Replace the keg. • Check if compressor is on and is not in failure mode (see compressor manual) • Air coupler not properly twisted on keg.
Air coupler is not activated	<ul style="list-style-type: none"> • Air coupler not properly twisted on keg. 	<ul style="list-style-type: none"> • Twist air coupler to 'ON' position
The beer is not cold	<ul style="list-style-type: none"> • The fridge is not plugged in. • The keg has not been cooled long enough. 	<ul style="list-style-type: none"> • Put the plug of the fridge into the socket and wait for 12 hours. • Check the time the keg was placed in the fridge. Keg must be cooled at least for 24 hours.
The beer line is stuck in the counter mount	<ul style="list-style-type: none"> • The hygienic cap on the spout is missing. • There is an obstruction in the counter mount. 	<ul style="list-style-type: none"> • Pull back the beer line and place the hygienic cap. (hygienic cap is needed to install the Disposable Beer Tube) • Contact your supplier.
Door alarm is ongoing	<ul style="list-style-type: none"> • Door is not fully closed. • Cabinet temperature is too low or too high for more than 3 hours. 	<ul style="list-style-type: none"> • Make sure kegs are on correct position, close the door. • Press 'mute' on the controller to stop the alarm. Check the system. Make sure the airflow is free of obstruction.
In case the problems are not solved, please contact your supplier		

11.2 Troubleshooting compressor

The status display provides the user with information about the current (error) state of the compressor. This can give the user a first chance of identifying the problem.

Problem	Possible cause	Solution
o.P.	<ul style="list-style-type: none"> • The pressure of the system is too high. 	<ul style="list-style-type: none"> • Check connected air hoses on blockings
u.P.	<ul style="list-style-type: none"> • The pressure of the system is too low 	<ul style="list-style-type: none"> • Check connected air hoses and couplings on leakage
r.o.	<ul style="list-style-type: none"> • The compressor has been running continuously for too long 	<ul style="list-style-type: none"> • Check the connected air system on leakage • Limit the use of the compressor • Consult Heineken
o.t.	<ul style="list-style-type: none"> • The temperature of the compressor too high. 	<ul style="list-style-type: none"> • Check if the compressor is placed on a sufficiently ventilated spot • Limit the use of the compressor • Consult Heineken
99.	<ul style="list-style-type: none"> • The compressor is overheated or over used and is shut down. A timer shows a cool down period countdown (99 – 0). 	<ul style="list-style-type: none"> • Check warning r.o. or o.t.
Empty	<ul style="list-style-type: none"> • The compressor does not receive power 	<ul style="list-style-type: none"> • Check if the power cable is properly connected/not damaged • Check the AC outlet • Replace blown fuse by spare • Consult Heineken

In case the problems are not solved, please contact your supplier

