

# DAVID XL GREEN

User Manual



# Content

<b>1. Safety instructions and warnings</b>	<b>5</b>
1.1 General	5
1.2 Working with CO <sub>2</sub>	6
1.3 Fridge areas	6
1.4 Customer contact	6
<b>2. Introduction</b>	<b>4</b>
<b>3. Disposal notes</b>	<b>4</b>
<b>4. Range of appliance use</b>	<b>4</b>
<b>5. Climate rating</b>	<b>6</b>
<b>6. Preparation</b>	<b>7</b>
6.1 Setting up	7
6.2 Connecting to the mains	7
6.3 Switching appliance on and off	7
6.4 Air ventilation	7
<b>7. Description of appliance and equipment</b>	<b>8</b>
7.1 Built in version	8
7.2 Mobile version	9
<b>8. Use of appliance</b>	<b>10</b>
8.1 Pouring beer	10
8.2 Removing the keg	10
8.3 Installing the keg	10
8.4 Changing / Connecting the CO <sub>2</sub> Cylinder	11
8.5 Cleaning	12
8.6 Alarm messages	12
<b>9. Shutting your appliance down</b>	<b>12</b>
<b>10. Technical Specifications</b>	<b>13</b>
<b>11. Trouble shooting</b>	<b>14</b>

# 1. Safety instruction and warnings

## 1.1 General

- To prevent injury or damage to the unit, the appliance should be unpacked and set up by two people.
- In the event that the appliance is damaged on delivery, contact the supplier immediately before connecting to the mains.
- To guarantee safe operation, ensure that the appliance is set up and connected as described in this installation manual.  
Disconnect the appliance from the mains if any fault occurs. Pull out the plug, switch off or remove the fuse.
- When disconnecting the appliance, pull on the plug, not on the cable.
- Any repairs and work on the appliance should only be carried out by the customer service department, as unauthorised work could prove highly dangerous for the user. The same applies to changing the mains power cable.
- Never use this appliance with a damaged power cord. A power cord which is damaged should be replaced immediately.
- Do not allow naked flames or ignition sources to enter the appliance. When transporting and cleaning the appliance ensure that the refrigerant circuit is not damaged. In the event of damage, make sure that there are no ignition sources nearby and keep the room well ventilated.
- The appliance is unsuited for use in areas exposed to an explosion hazard.
- Do not stand on the plinth, drawers or doors or use them to support anything else.
- This appliance is not intended for use by persons (including children) with reduced physical, sensory or mental capabilities or lack of experience and knowledge unless they have been given initial supervision or instruction concerning use of the appliance by a person responsible for their safety. Children should be supervised to ensure that they do not play with the appliance.
- If you have lockable appliance, do not keep the key near the appliance or within reach of children.
- Access to the service area is restricted to persons having knowledge and practical experience of the appliance.
- The appliance is only to be installed in locations where its use and maintenance is restricted to trained personnel.
- Avoid prolonged skin contact with cold surfaces or chilled/frozen food. This could cause pain, numbness and frostbite. In case of prolonged skin contact, protective measures should be taken, e.g. gloves should be worn.
- Do not use electrical appliances inside the appliance.

- Do not consume food which has been stored for too long, as it could cause food poisoning.
- Do not store explosives or sprays using combustible propellants such as butane, propane, pentane etc. in the appliance. Electrical components might cause leaking gas to ignite. You may identify such sprays by the printed contents or a flame symbol.
- The appliance is designed for use in enclosed areas. Do not operate the appliance outdoors or in areas where it is exposed to splash water or damp conditions.
- The Appliance is not suitable for installation in an area where a water jet could be used.
- Special-purpose lamps (incandescent lamps, LEDs, fluorescent tubes) in the appliance serve to illuminate the appliance interior and are not suited for room illumination.
- Maximal installation height to use the David system: 2 km above sea level.
- Handle the David draught beer installation with care.
- Illuminated column (LED lights) may only be used with the internal adaptor for illumination of the appliance.

## 4.2 Working with CO<sub>2</sub>

- **Carbon dioxide (CO<sub>2</sub>) gas is a dangerous gas. When you hear gas leaking, check the whole system. If the dispense tool is connected to the keg, it should be locked.**
- **The gas cylinders are under high pressure (up to 80 bar). Therefore handle the cylinders with care.**
- **Do not drop the gas cylinders.**
- **Do not expose the cylinders to high temperatures.**
- **Only mechanics of your supplier are allowed to carry out maintenance or repair of technical failures.**
- **Always connect the gas cylinders to the reducing valve.**
- **Never try to connect the gas cylinder directly to the beer keg**
- **Never connect the gas cylinder to any equipment not provided by the brewery.**
- **Always secure the cylinder in upright position while in use.**
- **Never remove fittings from the gas cylinders or kegs.**



### 1.3 Fridge areas

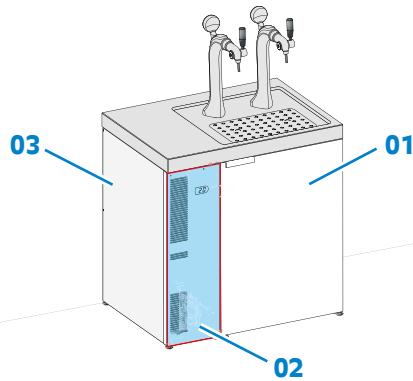

#### Legenda

- 01 User area / Cabinet
- 02 Service area behind front cover (Sheet metal)
- 03 Cooling cassette

### 1.4 Customer contact

When contacting your supplier or the Service Department, please quote the model and serial number of your appliance. Both of which are shown on the type label visible inside the cooling cabinet.

You can download the user manual for your appliance from the Heineken website ([www.draughtsystems.heineken.com](http://www.draughtsystems.heineken.com)).

## 2. Introduction

The David XL Green draught beer installation has been designed specifically to simply use four kegs in a well-cooled and hygienic way.

The newly designed refrigeration system provides rapid cooling of newly placed (warm) kegs as well as a cooled counter mount and beer tube even at high ambient temperatures.

The refrigerator system is using Hydro Carbon refrigerant and high efficient components, to reduce the energy consumption and environmental impact.

This user manual provides instructions for the use of the draught beer installation. In this manual you will also find the safety regulations you must observe while using the machine. Always keep this manual with the draught beer installation, so you can consult it when necessary.

**Read the operating instructions before switching on for the first time.**

## 3. Disposal notes

Keep packaging materials away from children  
- polythene sheets and bags can cause suffocation!



- Please return the packaging to an official collection point.

**Your old appliance:** This contains some reusable materials and should be disposed of properly - not simply with unsorted household refuse.

- Discarded appliances should be disabled: Remove the plug, cut through the connection cable and render the catch unusable so that children cannot become trapped inside.
- Ensure that the refrigerant circuit is not damaged when the appliance that is no longer needed is taken away for disposal.
- Details of the refrigerant can be found on the type plate.
- Appliances which are no longer needed must be disposed of in a professional and appropriate way, in accordance with the current local regulations and laws.



## 4. Range of appliance use

- The appliance is suited only for cooling beer kegs and non alcohol or low alcohol beverage kegs.
- In the case of commercial food cooling, the pertinent statutory regulations have to be observed.
- The appliance is not suited for storing and cooling pharmaceuticals, blood plasma, laboratory preparations or similar substances and products subject to the Medical Devices Directive 2007/47/EC.
- Any misuse of the appliance may result in damage to or spoilage of the stored goods.
- Furthermore, the appliance is unsuited for use in areas exposed to an explosion hazard.

## 5. Climate rating

The appliance is set to operate within specific ambient temperature limits according to its climate rating. These temperature limits should not be exceeded.

	Ambient temperatures	Relative Humidity
Single / Twin tap	+10 °C to +38°C	75% RH

## 6. Preparation

### 6.1 Setting up

- Avoid positioning the appliance in direct sunlight or near cookers, radiators and similar sources of heat.
- The floor on which the appliance stands should be horizontal and level. Compensate for uneven floors with the adjustable feet.
- Always ensure that there is good ventilation and that the outward flowing air is able to escape.
- Standard EN 378 specifies that the room in which you install your appliance must have a volume of 1 m<sup>3</sup> per 8 g of R 290 refrigerant used in the appliance, so as to avoid the formation of inflammable gas/air mixtures in the room where the appliance is located in the event of a leak in the refrigerant circuit. The quantity of refrigerant used in your appliance is indicated on the type plate on the inside of the appliance.
- Do not connect the appliance to the supply with other equipment using an extension cable - risk of overheating.
- Before moving the appliance to another position, make sure that the plug is removed from the electricity supply.

### 6.2 Connecting to the mains

**Connect the appliance with a properly earthed fused plug and socket only.**



Power supply (a.c.) and voltage at the operating point must comply with the details on the type plate. The socket must be fused with a 10 A fuse or higher (Max 16 A), it must be away from the rear of the appliance and must be easily accessible.

The power plug must be accessible after the appliance has been built in.

### 6.3 Switching appliance on and off

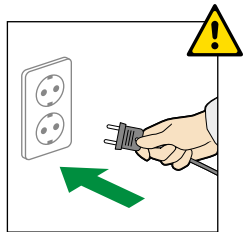

**To switch the appliance on:** Connect the appliance to the mains - the appliance is switched on.

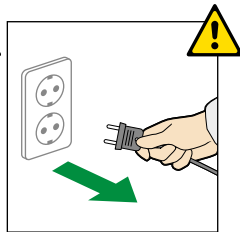

**To switch the appliance off:** Pull out the mains plug.

### 6.4 Air ventilation

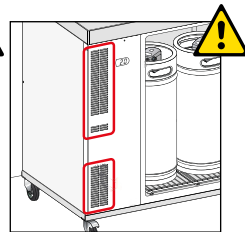

Always keep the air ventilation grill open!  
Do not block the airflow.

## 7. Description of appliance and equipment

### 7.1 Built in version

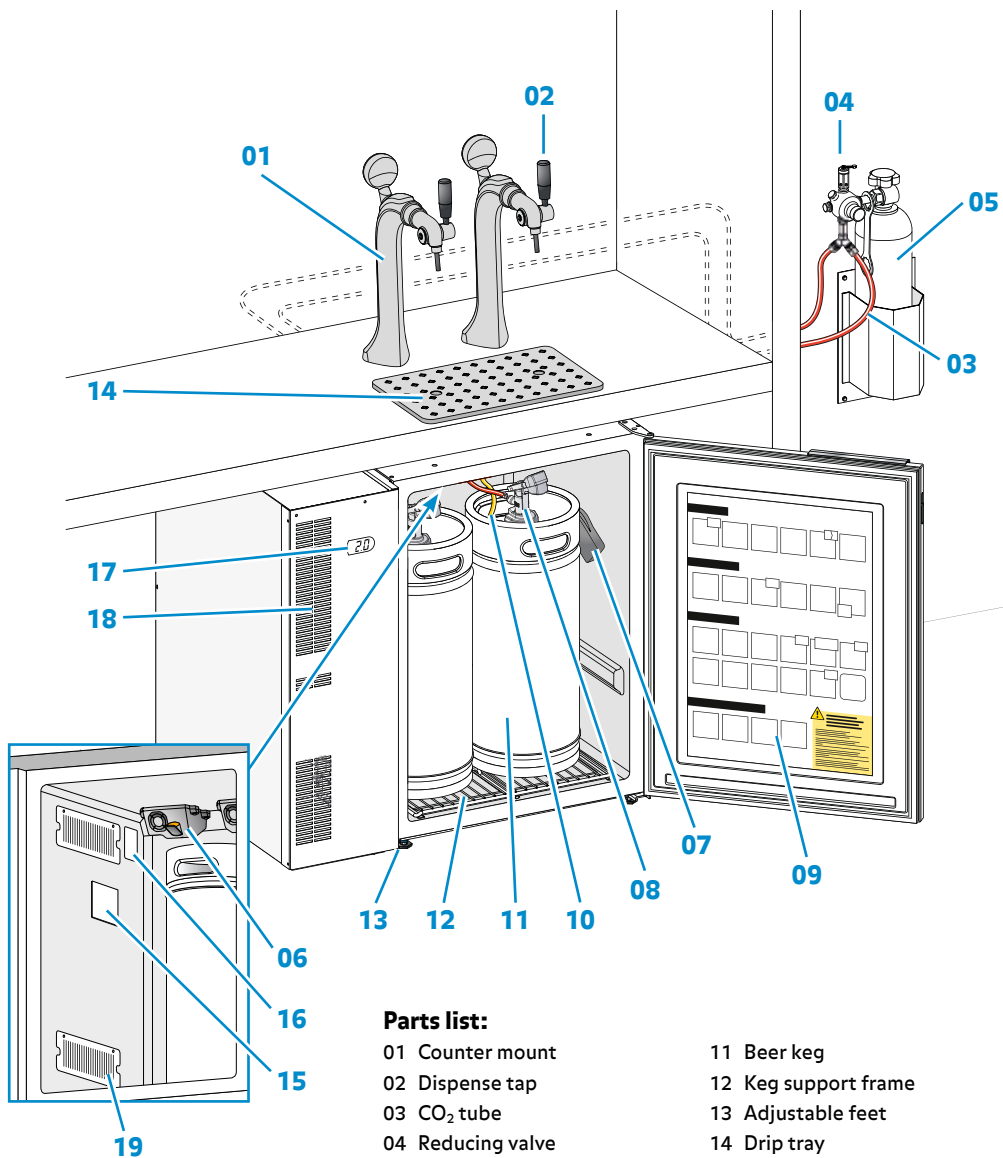

#### Parts list:

- |                             |   |
|-----------------------------|---|
| 01 Counter mount            | 11 Beer keg                             |
| 02 Dispense tap             | 12 Keg support frame                    |
| 03 CO <sub>2</sub> tube     | 13 Adjustable feet                      |
| 04 Reducing valve           | 14 Drip tray                            |
| 05 CO <sub>2</sub> cylinder | 15 Type plate                           |
| 06 Beer tube inlet          | 16 Fridge light                         |
| 07 Dispense tool holder     | 17 Controller display                   |
| 08 Dispense Hand tool       | 18 Air ventilation grill                |
| 09 Quick reference sticker  | 19 Air ventilation grill<br>(Removable) |
| 10 Beer tube                |   |

### 7.2 Mobile version

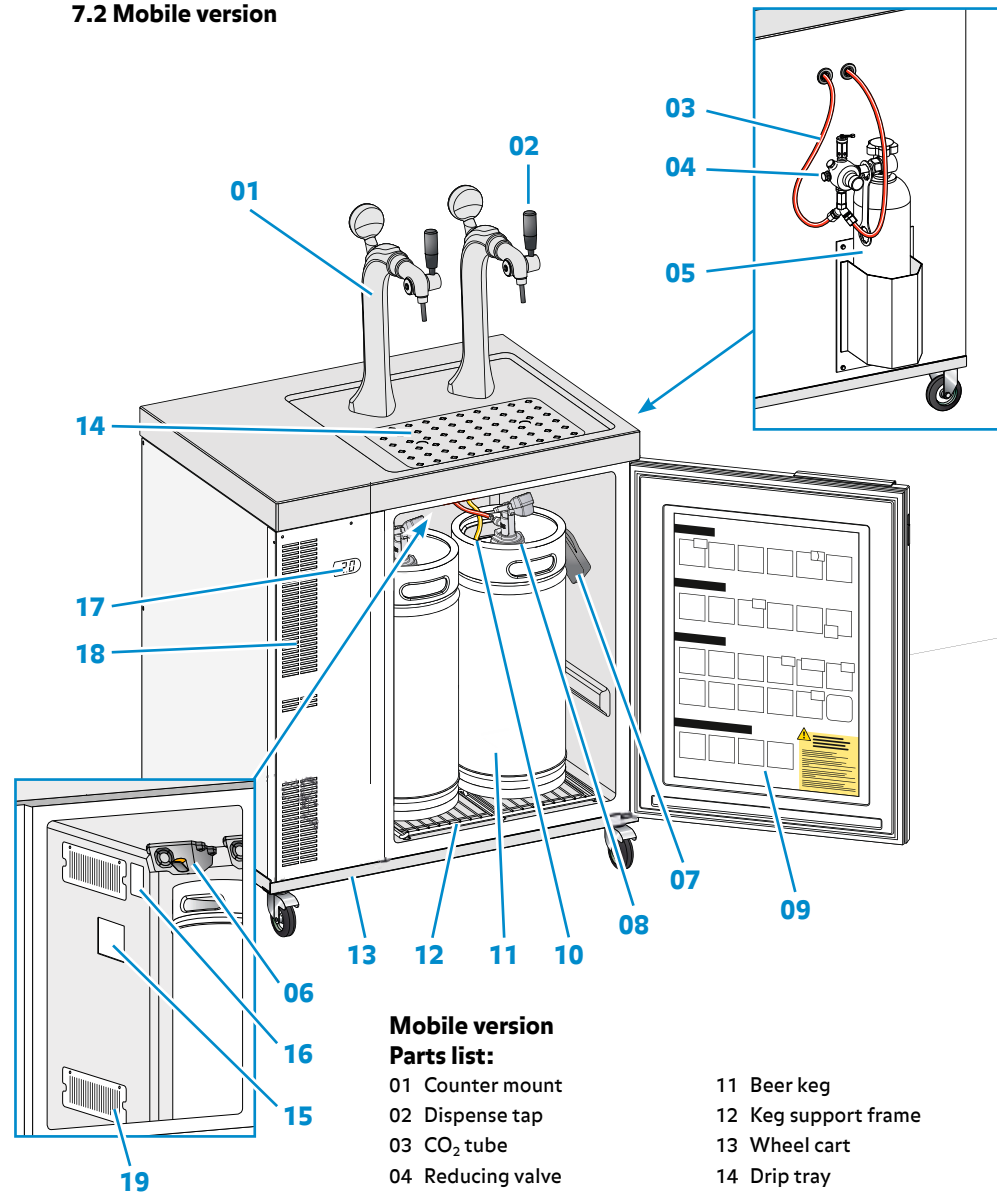

#### Mobile version

#### Parts list:

- |                             |   |
|-----------------------------|---|
| 01 Counter mount            | 11 Beer keg                             |
| 02 Dispense tap             | 12 Keg support frame                    |
| 03 CO <sub>2</sub> tube     | 13 Wheel cart                           |
| 04 Reducing valve           | 14 Drip tray                            |
| 05 CO <sub>2</sub> cylinder | 15 Type plate                           |
| 06 Beer tube inlet          | 16 Fridge light                         |
| 07 Dispense tool holder     | 17 Controller display                   |
| 08 Dispense Hand tool       | 18 Air ventilation grill                |
| 09 Quick reference sticker  | 19 Air ventilation grill<br>(Removable) |
| 10 Beer tube                |   |

## 8. Use of appliance

### 8.1 Pouring beer

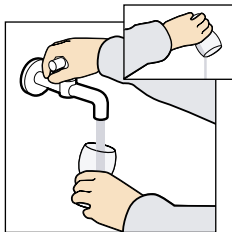

1. Always use glasses rinsed with water

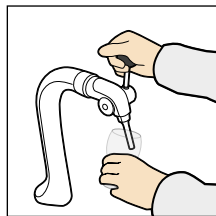

2. Hold glass in a tilted position

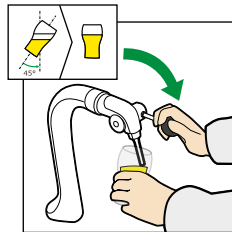

3. Open tap  
4. Dispense beer

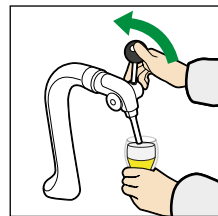

5. Close tap when glass is full. Cheers!

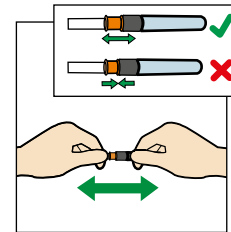

5. Check beer spout

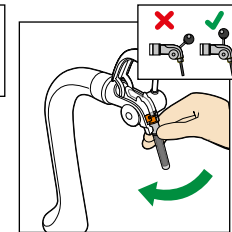

6. Insert beer spout in dispensing tap

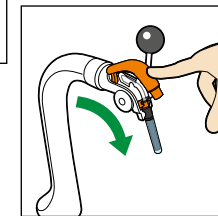

7. Close dispensing tap

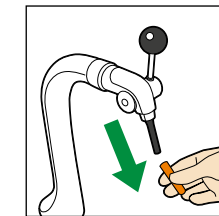

8. Remove hygienic cap

### 8.2 Removing the keg

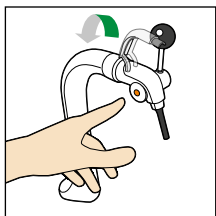

1. Push knob to open dispensing tap

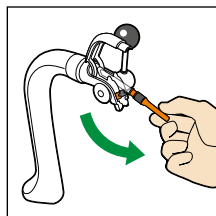

2. Disconnect beer spout

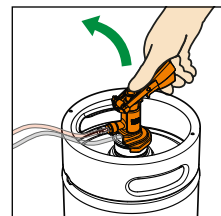

3. De-activate dispensing tool

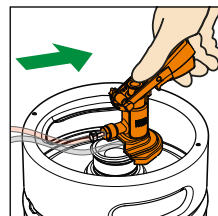

4. Disconnect dispensing tool

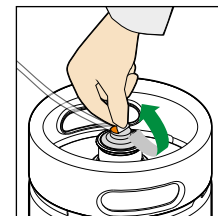

9. Remove aluminum seal

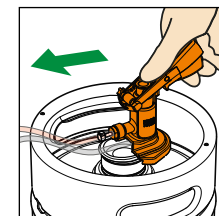

10. Place dispensing tool

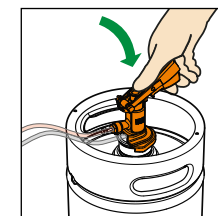

11. Activate dispensing tool

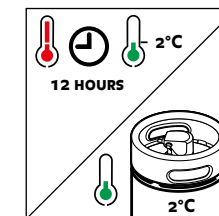

12. Wait for 12 hours before pouring or use precooled keg

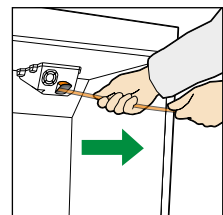

5. Remove beer line

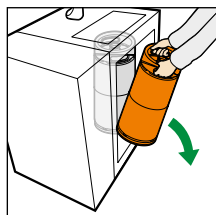

6. Remove keg

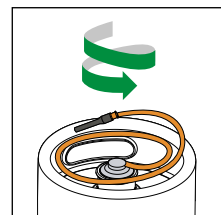

7. Store the beer tube inside the keg rim

### 8.3 Installing the keg

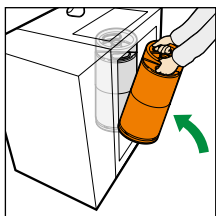

1. Place new keg

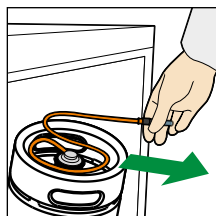

2. Unreel beer tube of cold keg

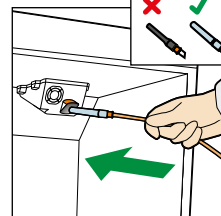

3. Insert beer tube with hygienic cap

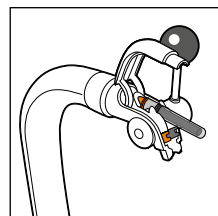

4. Push until it appears at dispensing tap

### 8.4 Changing / Connecting the CO<sub>2</sub> cylinder

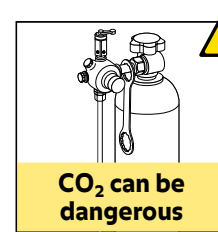

CO<sub>2</sub> can be dangerous

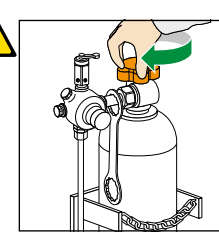

1. Close gas cylinder

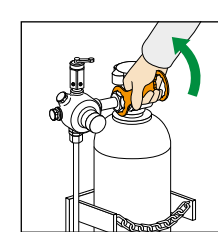

2. Disconnect reducing valve manually

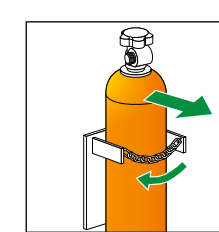

3. Disconnect safety chain and take out empty cylinder

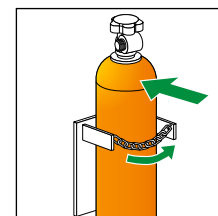

4. Place and secure new cylinder

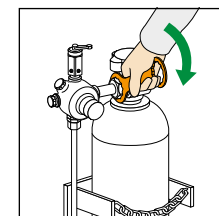

5. Connect reducing valve manually

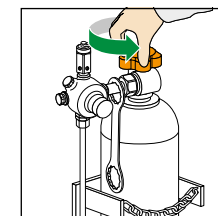

6. Open cylinder

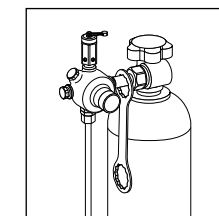

7. Works only when CO<sub>2</sub> cylinder is open and contains enough CO<sub>2</sub>

## 8.5 Cleaning

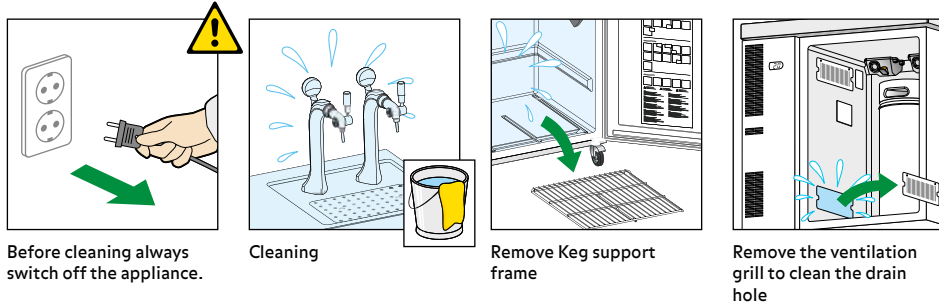

- Do not disassemble the dispense system. Do not open the machine. If you have any problems contact your supplier.
- Before cleaning always switch off the appliance. Pull out the mains plug or remove/unscrew the fuse.
- Do not use steam cleaners because of the risk of injury and damage.



- Clean the inside, equipment parts and outer walls with lukewarm water and a little detergent. Do not use abrasive or acid cleaners or chemical solvents.
- Ensure that no cleaning water penetrates into the electrical components or ventilation grille.
- Clean the drain hole in the refrigerator compartment with a thin object, e.g. cotton swab or the like.
- Do not damage or remove the type plate on the inside of the appliance. It is very important for servicing purposes.
- The appliance must be cleaned 2 times a year
- About 1-2 times a year the condenser grid should be removed from its place in order to undust the condenser pipe-system.
- Cleaning increases the lifetime of the machine and has an influence on the performance and electric consumption. A soft brush or vacuum cleaner may be used for cleaning.

## 8.6 Alarm message

The appliance contains an alarm that sounds as soon as the door is opened for more than 2 minutes. Close the door to stop the alarm. Make sure both kegs are positioned correctly.

## 9. Shutting your appliance down

If your appliance is to be shut down for any length of time, switch it off and disconnect the plug or remove the fuse. Clean the appliance and leave the door open in order to prevent unpleasant smells. The appliance complies with the relevant safety regulations and EC directives 2004/108/EC and 2006/95/EC.

## 10. Technical Specifications

Technical specifications of the David Green Draught beer installation	
Dimensions of fridge outside (excluding door handle)	836 x 858 x 597 mm (height x width x depth)
Minimum Built-in dimensions	870 x 875 x 600 mm (height x width x depth)
Mains supply	See type label inside fridge
Electrical connecting rating	See type label inside fridge
Climate class	7
Maximum working conditions	+ 38°C / 75% Relative Humidity
Minimum working conditions	+ 10°C / 75% Relative Humidity
Setpoint range	+ 0°C to +6°C
Default setpoint	+ 2°C (locked setpoint)
Defrosting	The refrigerator compartment defrosts automatically
Keg storage	4 x 20 Liter David beer kegs of specific dimensions
Cooling down time (at 38°C / 75% RH)	For one full beer keg from +38°C to +2°C in maximum 24 hours
Keg interchange	Less than 1 minute
Refrigerant	See type label inside fridge
Energy consumption (at 25°C / 60% RH)	Less then 2,0 kWh/24h (steady state)
Weight of the fridge	54 kg
Noise level	Less then 50dB(A)
Start up delay	3 Minutes
Cabinet illumination	3 Watt LED
Counter mount	One or two Counter mounts with cold air circulation
Dispense tap (DTA)	15 or 90 degrees stroke angle (must be connected with disposable beer tube)
Dispense Hand tool (DHT)	Manual operated dispense tool for David.
CO <sub>2</sub> reducing valve	Mounted on CO <sub>2</sub> bottle. Pre-set at 0.7 bar (adjustable between 0.6 and 1.2 bar) to maintain the equilibrium pressure.
Tenability	30 days after connecting the beer container
I.P. rating	For indoor use only (IPX0)
Alarm message (acoustic)	Alarm will be activated when the door is opened for more than 2 minutes or when the cabinet temperature is too low or too high for more than 3 hours.
Not included	<ul style="list-style-type: none"> <li>• CO<sub>2</sub> cylinder</li> <li>• Beer container</li> <li>• Disposable Beer Tube</li> </ul>



# 11. Troubleshooting

Problem	Possible cause	Solution
<b>There is too much foam</b>	<ul style="list-style-type: none"> <li>• Beer has not rested long enough.</li> <li>• The beer is too warm.</li> <li>• The fridge is not plugged in.</li> <li>• The dispense tap has not been opened completely or was opened too slowly.</li> <li>• There is a kink in the beer line.</li> <li>• The keg is (almost) empty.</li> </ul>	<ul style="list-style-type: none"> <li>• Allow the keg 6 hours rest.</li> <li>• Check the time when the keg was placed in the fridge. Keg must be cooled for at least 12 hours.</li> <li>• Put the plug of the fridge into the socket and wait for 12 hours.</li> <li>• Put the handle towards you in one fast movement.</li> <li>• Remove kink from beer line.</li> <li>• Connect a new keg.</li> </ul>
<b>There is (practically) no beer running from the tap</b>	<ul style="list-style-type: none"> <li>• The keg is not connected correctly.</li> <li>• There is a kink in the beer line or CO<sub>2</sub> line.</li> <li>• The keg is empty.</li> <li>• The CO<sub>2</sub> cylinder is empty.</li> </ul>	<ul style="list-style-type: none"> <li>• Check the connection to the keg, make sure the temper evident seal (aluminum seal) is removed from the keg.</li> <li>• Remove kink from the beer line or CO<sub>2</sub> line.</li> <li>• Replace the keg.</li> <li>• Replace the CO<sub>2</sub> cylinder.</li> </ul>
<b>The beer is not cold</b>	<ul style="list-style-type: none"> <li>• The fridge is not plugged in.</li> <li>• The keg has not been cooled long enough.</li> </ul>	<ul style="list-style-type: none"> <li>• Put the plug of the fridge into the socket and wait for 12 hours.</li> <li>• Check the time the keg was placed in the fridge. Keg must be cooled at least for 12 hours.</li> </ul>
<b>The beer line is stuck in the counter mount</b>	<ul style="list-style-type: none"> <li>• The hygienic cap on the spout is missing.</li> <li>• There is an obstruction in the counter mount.</li> </ul>	<ul style="list-style-type: none"> <li>• Pull back the beer line and place the hygienic cap. (Hygienic cap is needed to install the Disposable Beer Tube).</li> <li>• Contact your supplier.</li> </ul>
<b>Door alarm is ongoing</b>	<ul style="list-style-type: none"> <li>• Door is not fully closed.</li> <li>• Cabinet temperature is too low or too high for more than 3 hours.</li> </ul>	<ul style="list-style-type: none"> <li>• Make sure kegs are on correct position, close the door.</li> <li>• Press 'mute' on the controller to stop the alarm. Check the system. Make sure the airflow is free of obstruction.</li> </ul>
<b>In case the problems are not solved, please contact your supplier</b>		

